

POINT

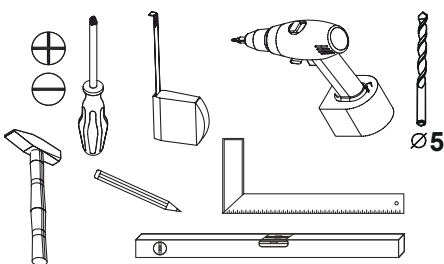

festziehen / tighten / Затягнете / serrer / stringere / utåhndout / vasttrekken / zategnuti / strångere / zwiázac / zacisnaç szorosan meghúzni / pevne dotiahnuť / trdno pritegniti / затянуть / dra át

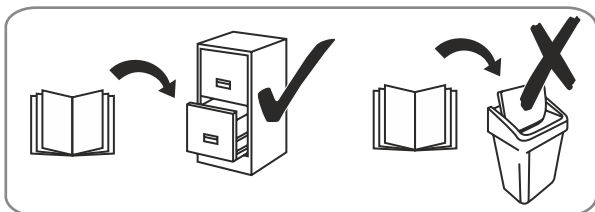
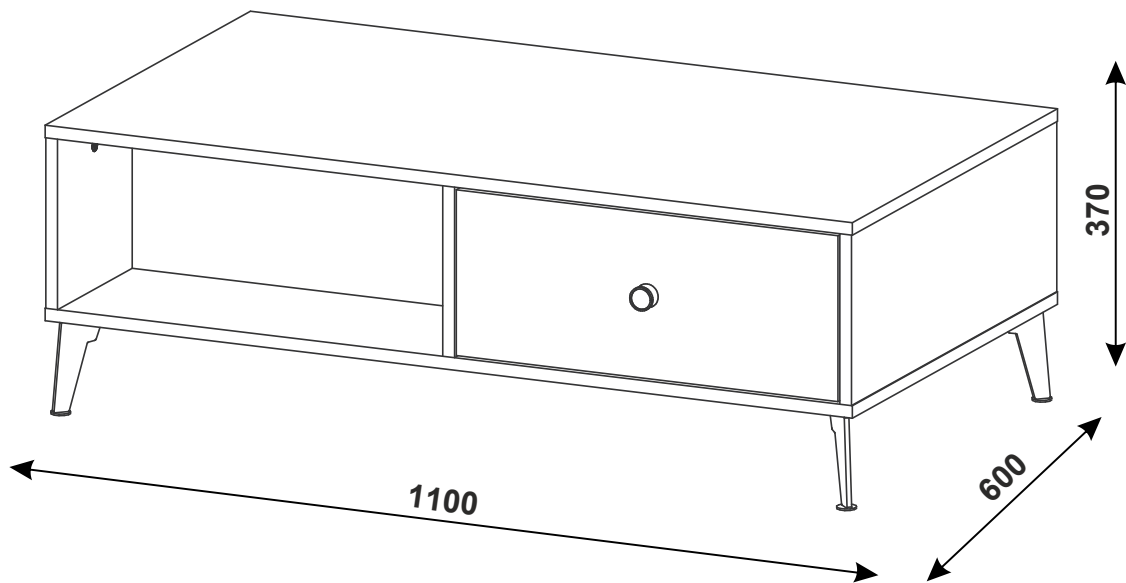

eindrücken / press in / enfoncer / wcisnaç ribattere / zatlačit / Вкарайте / indrukken benyomni / stlačit / vtišniti / tryck in introducere prin apăsare / вдавить



ausmessen / measure / mesurer / misurare / opmeten / izmeriti / miara / kímérni / izmeriti / măsurare / измерить змѣрит / Измерете / mät upp / zmierzyc



drücken / press / presser / stisknout / Натиснете / vtišniti / nasinac / drukken / pritisnuti / nacisnac / pritisniti / нажать / (meg)nyomni / apăsare / tryck fast / nacisnaç



einschlagen / hammer in / beverni / sla in frapper au marteau / infossare / Zabit' / zarazit / Набийте / zabiti / wbic' introducere prin bătaie / забить / zatlouct



Drehen - wenden / przekreć - odwrócić / Keren - omdraaien / Girare - Ruotare / Okrenuti - ubnuti / Retourner - renverser / Turn over - turn around / Otočte - obratite / Zавъртете - обърнете / Obrnite list / Ътоарсеџ - rotiџ / Vrid runt - vänd / прокрутить - повернуть / otočit - obrátit elforgatni - megfordítani



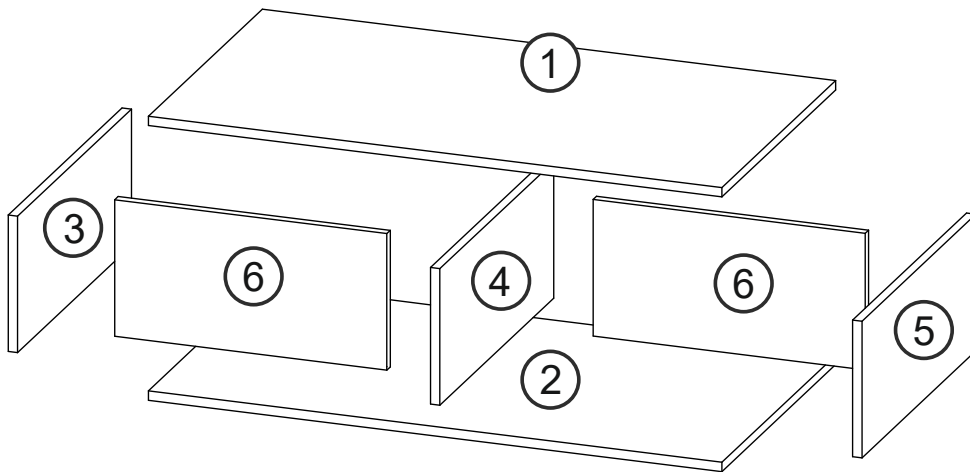
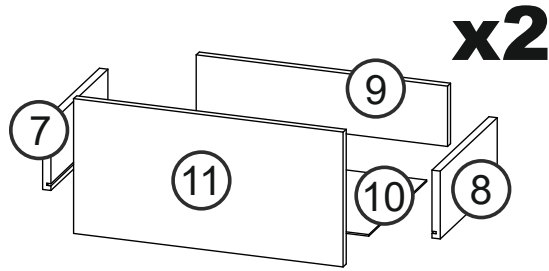
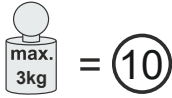
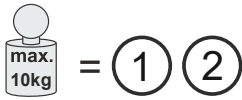









POINT

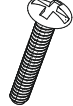

A	B (mm)			C	D
1	1100	600	16	x1	1/1
2	1100	600	16	x1	1/1
3	218	598	16	x1	1/1
4	218	598	16	x1	1/1
5	218	598	16	x1	1/1
6	218	525	16	x2	1/1
7	300	130	16	x2	1/1
8	300	130	16	x2	1/1
9	485	116	16	x2	1/1
10	499	307	2.5	x2	1/1
11	520	212	16	x2	1/1
B1					1/1

POINT

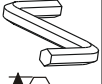
B1

A0  Ø8x30 x44	B07  Ø13 x6	B1  Ø6,4x50 x14	C07  Ø20 x4	C08  Ø20 x10	C1  16 mm x14	C2  L-44 x14	D11  3.5x15 x12	D17  3.5x16 x22	D19  4x16 x2	L14  x2
T10  x4	Z  4mm x1	N12  L-300 x2	B08  Ø13 x8							

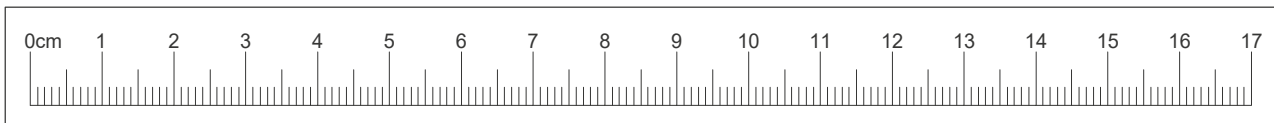

1

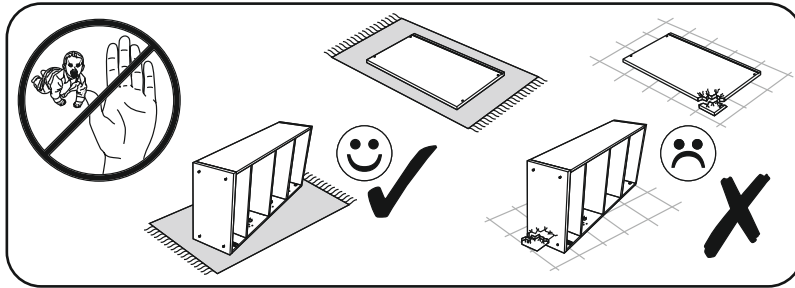



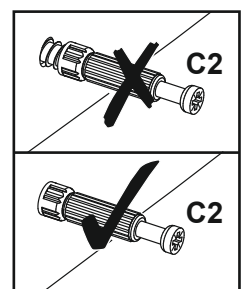
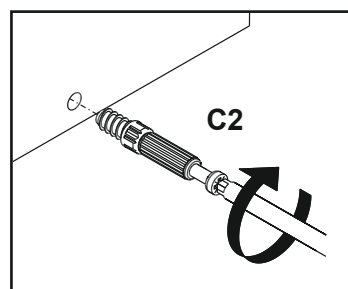
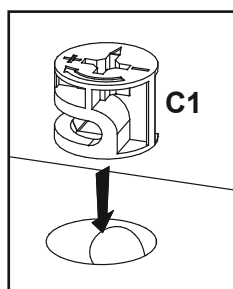
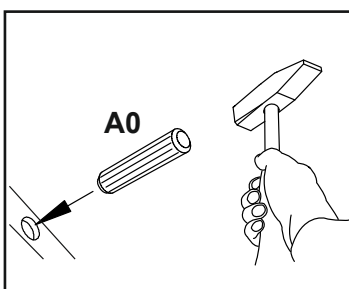
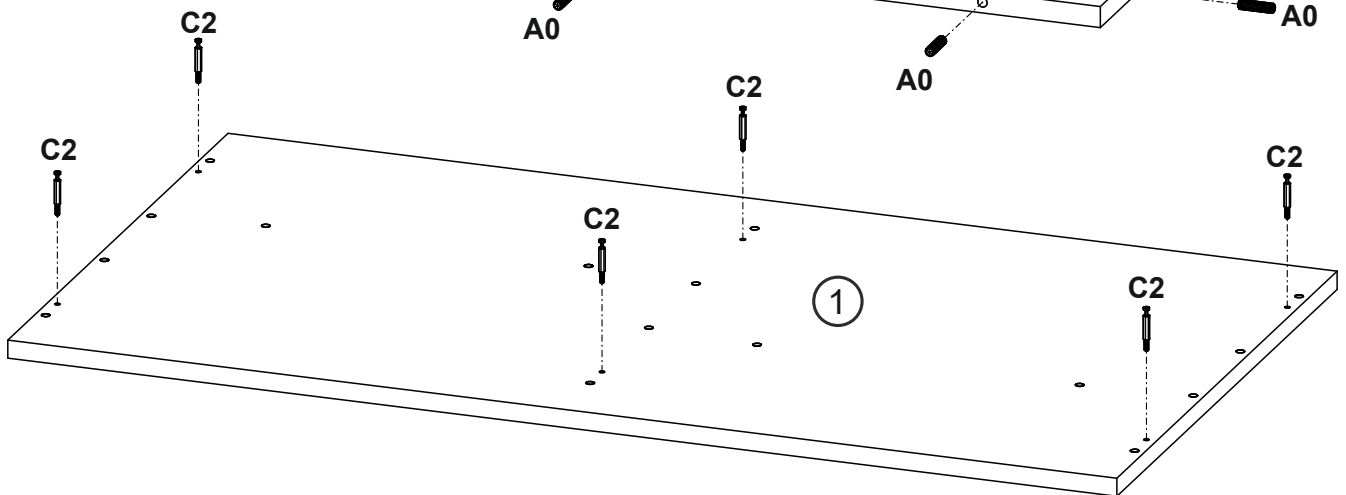
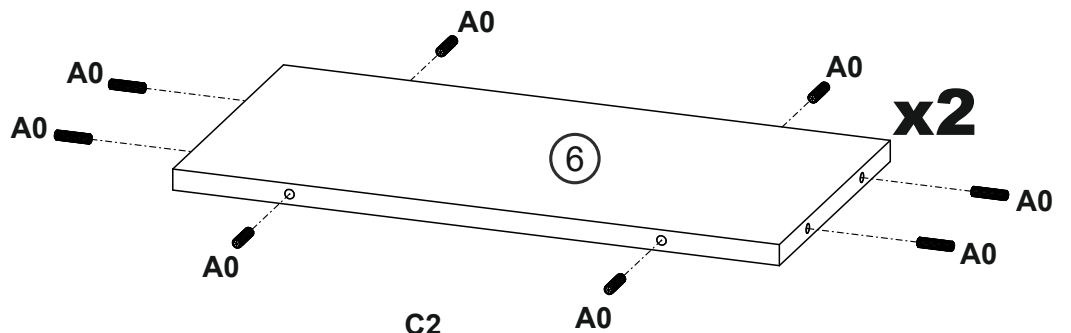
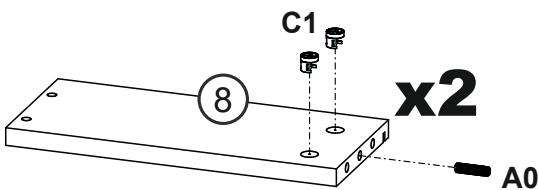
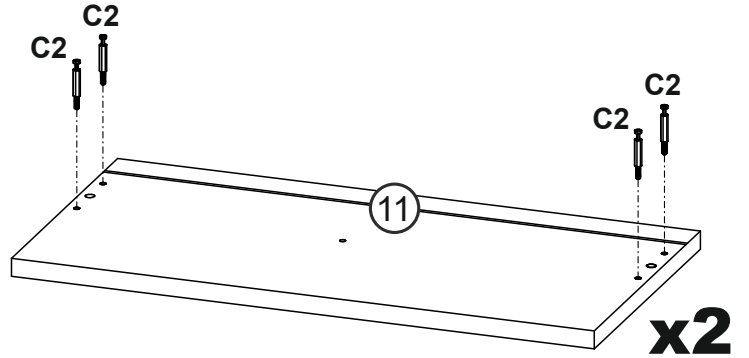
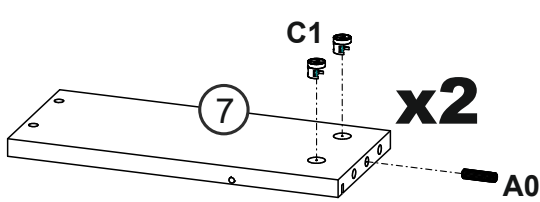

A0 Ø8x30 x20	C1 16 mm x8	C2 x14
--------------------------------------	-------------------------------------	-----------------------------

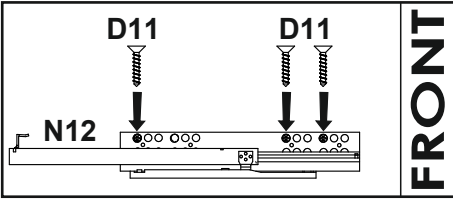

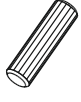
2



A0  Ø8x30 x24	C1  16 mm x6	D11  3,5x15 x12	N12  L-300 x2
---	--	---	---

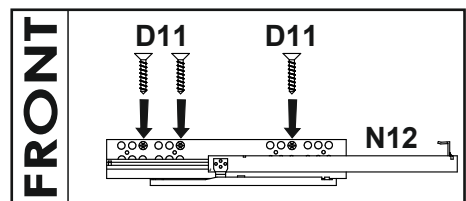
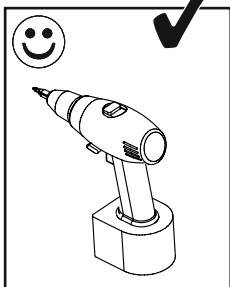
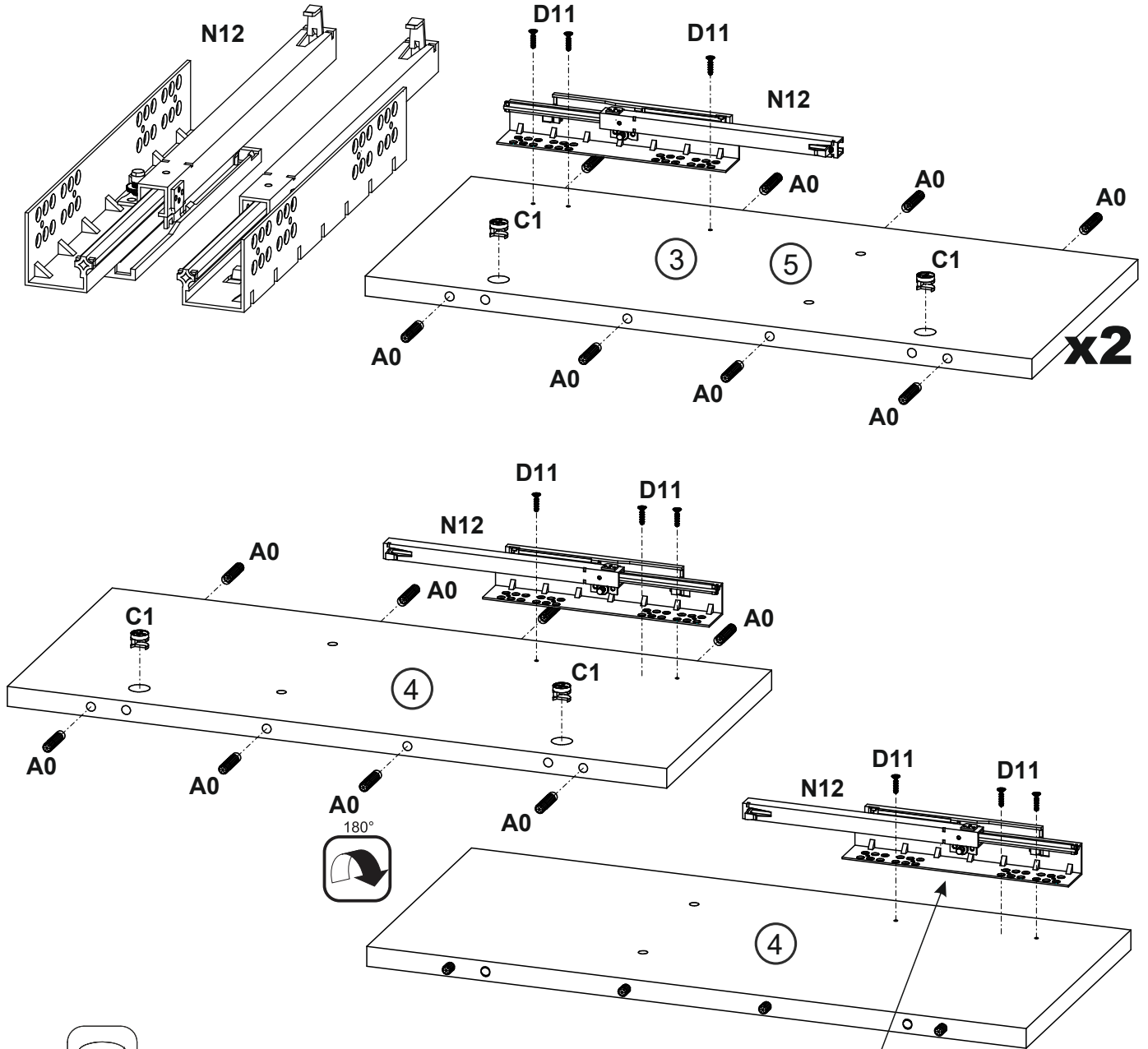

3

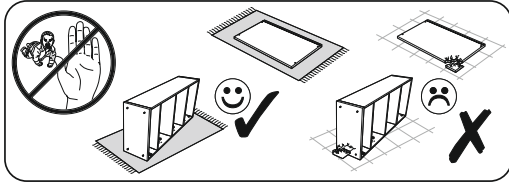
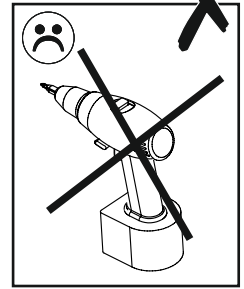
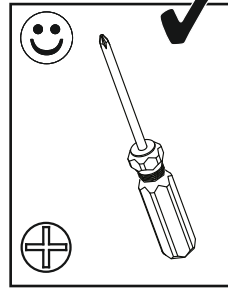
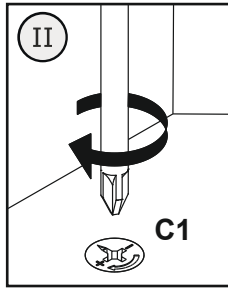
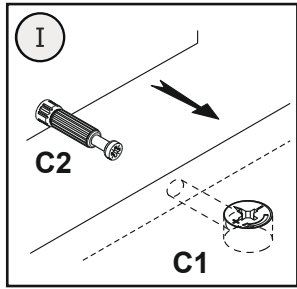
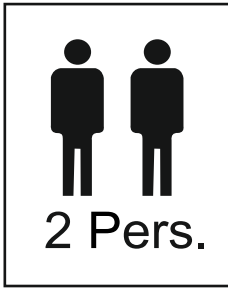

I

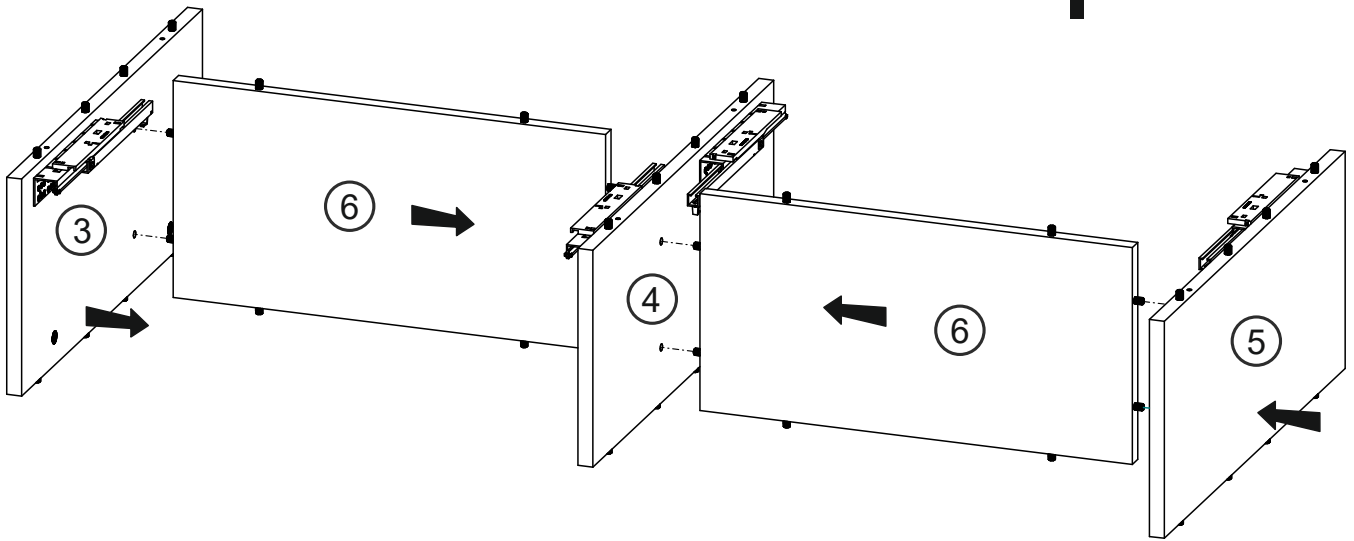

II

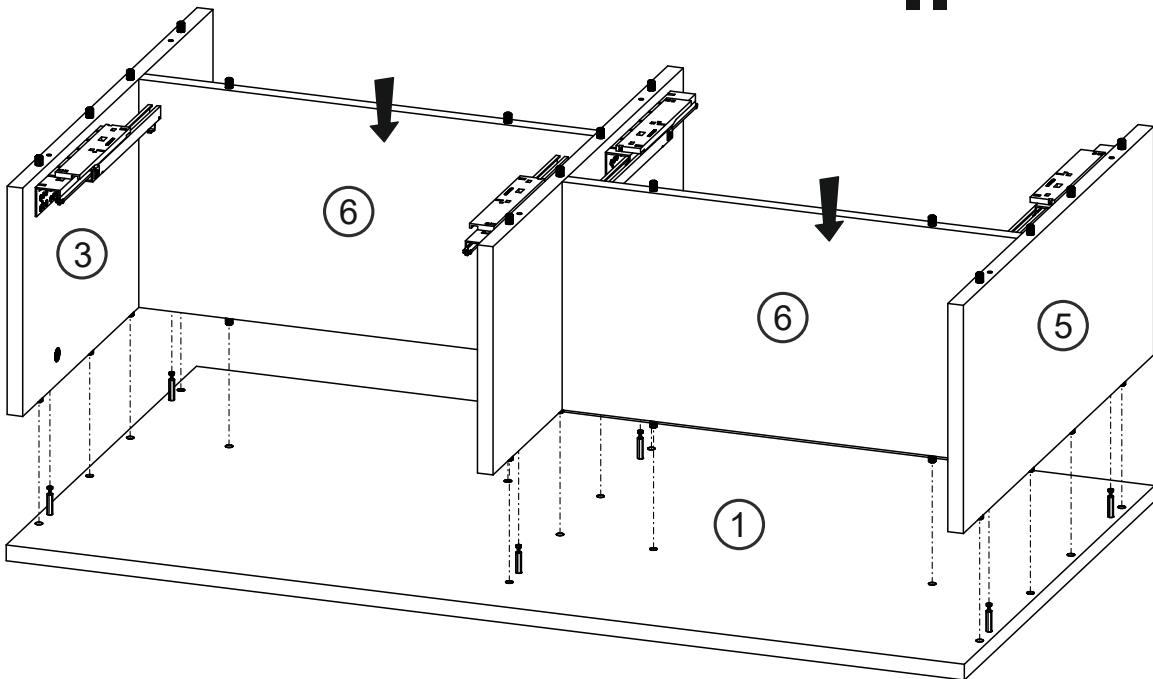

4

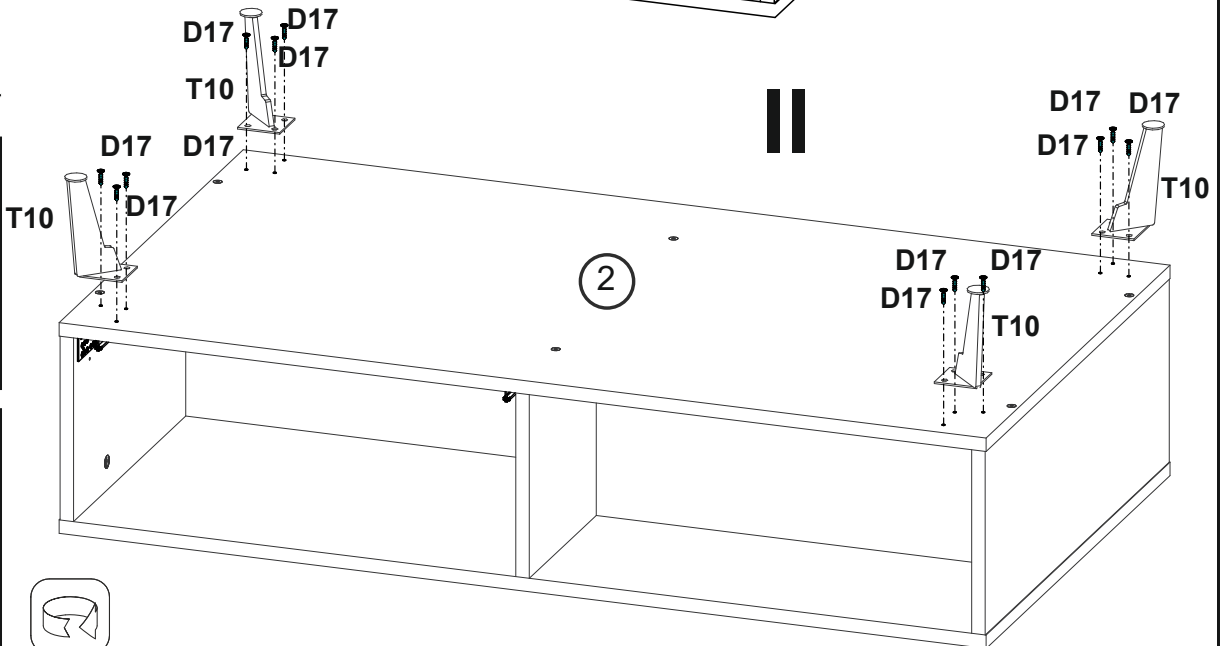
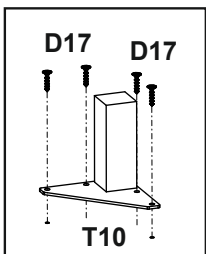
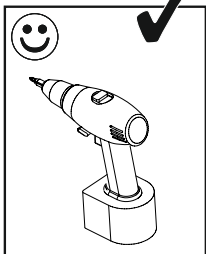
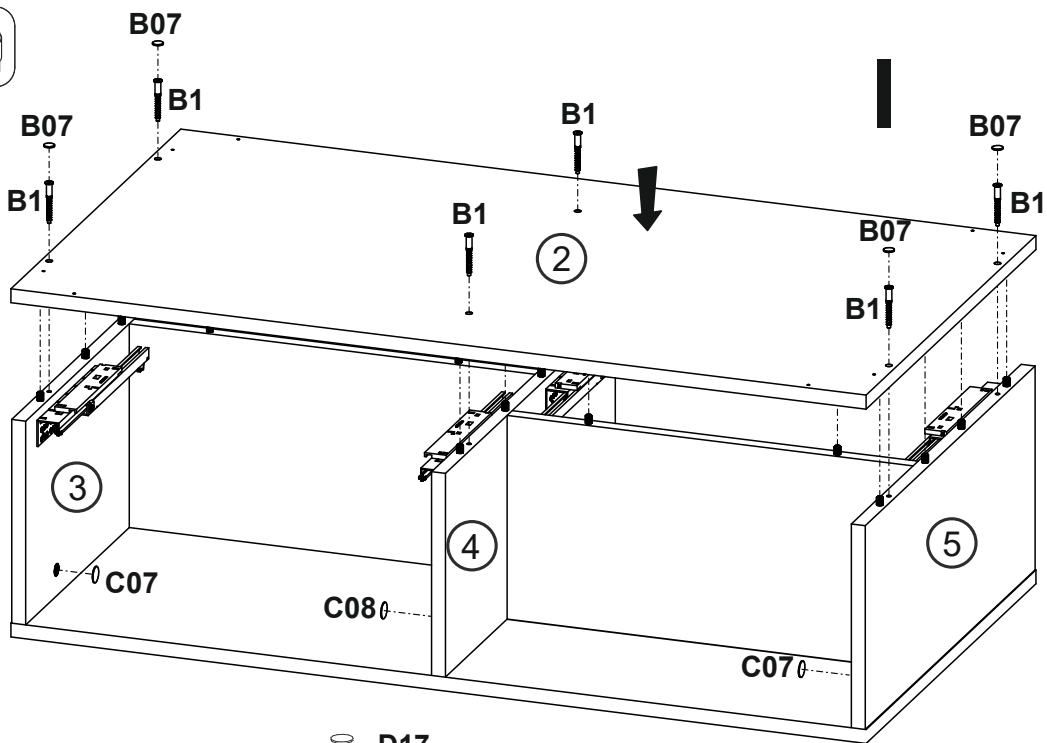
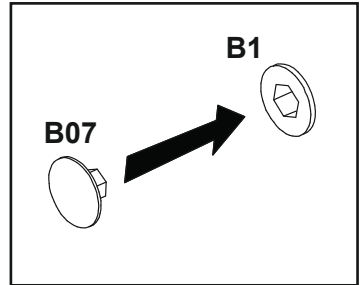
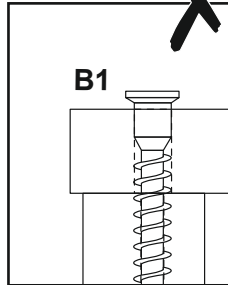
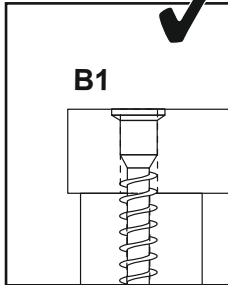
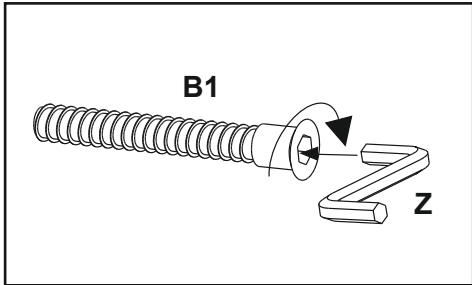
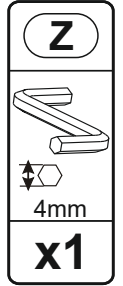
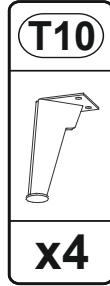
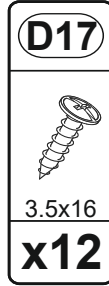
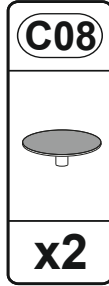
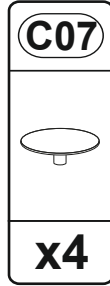
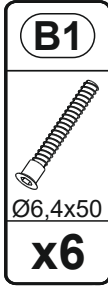
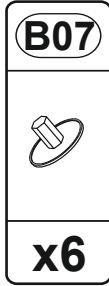
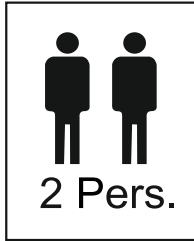
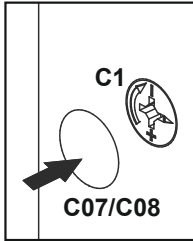

5

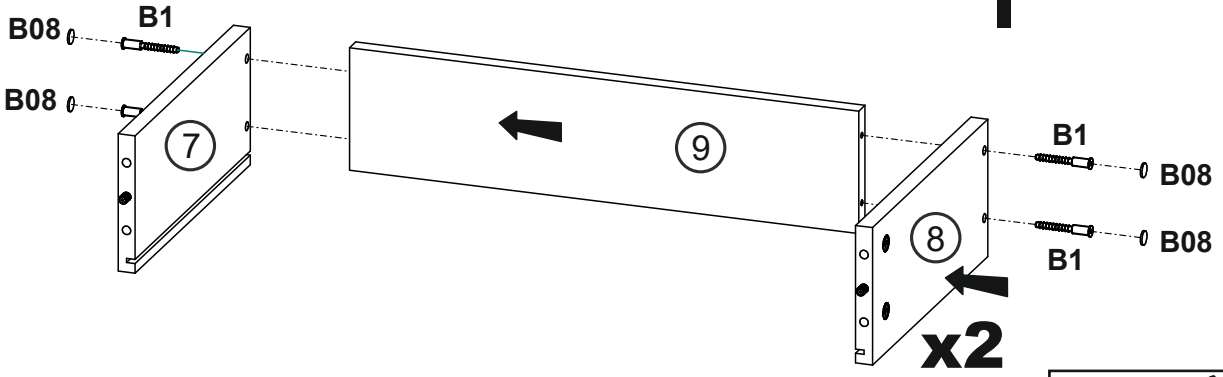
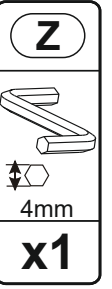
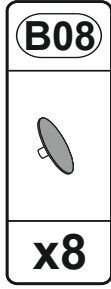
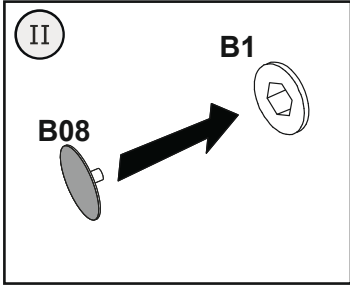
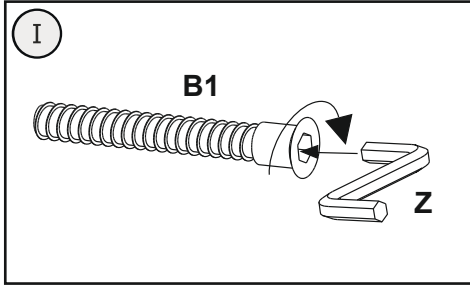

I

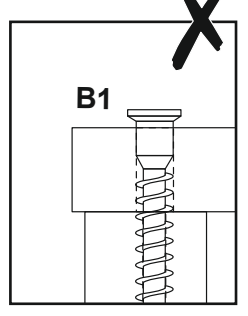
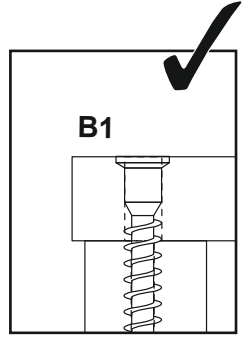
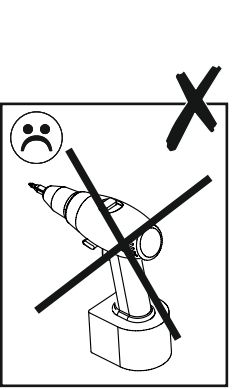
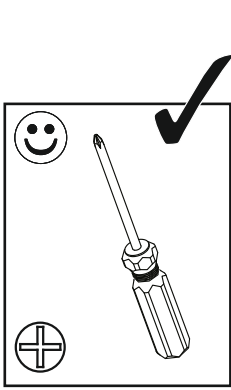
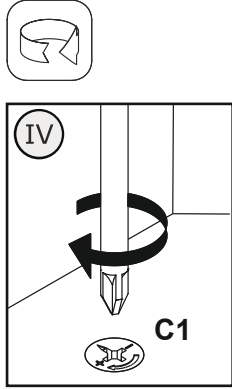
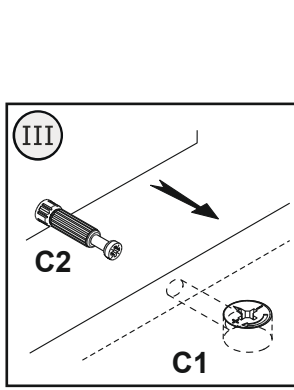

II

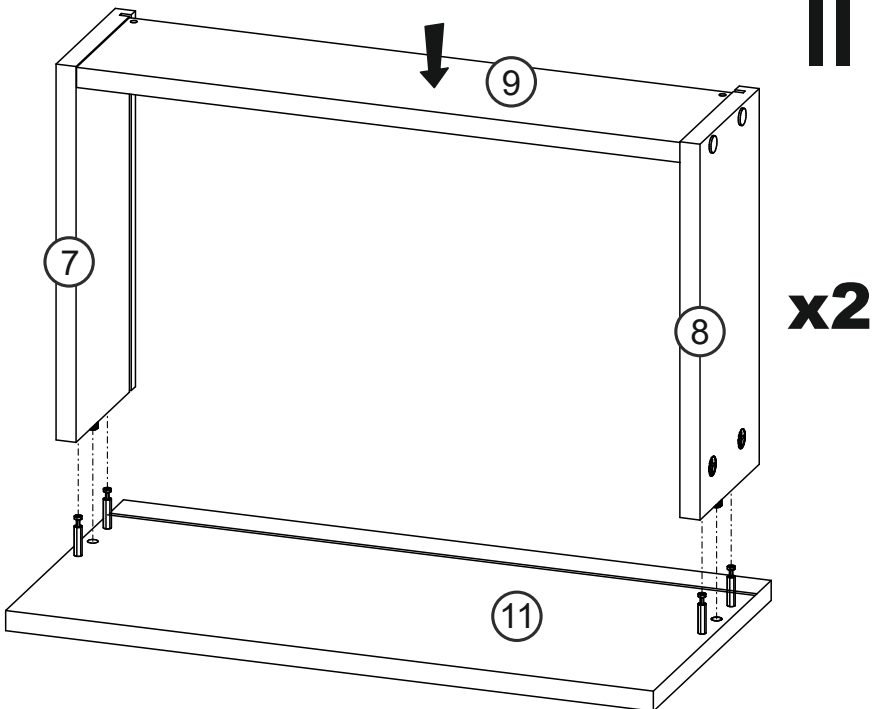

7

