

POINT

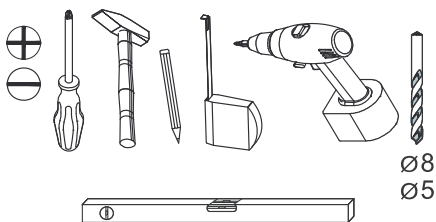

festziehen / tighten / Затягнете /
serrer / stringere / utåhnut / vasttrekken /
zategnuti / strângere / zwiázac / zacisnaç
szorosan meghúzni / pevne dolahnut' /
trdno pritegniti / затянуть / dra át

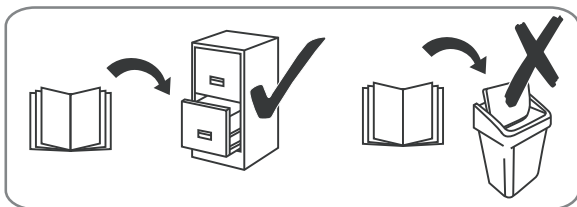
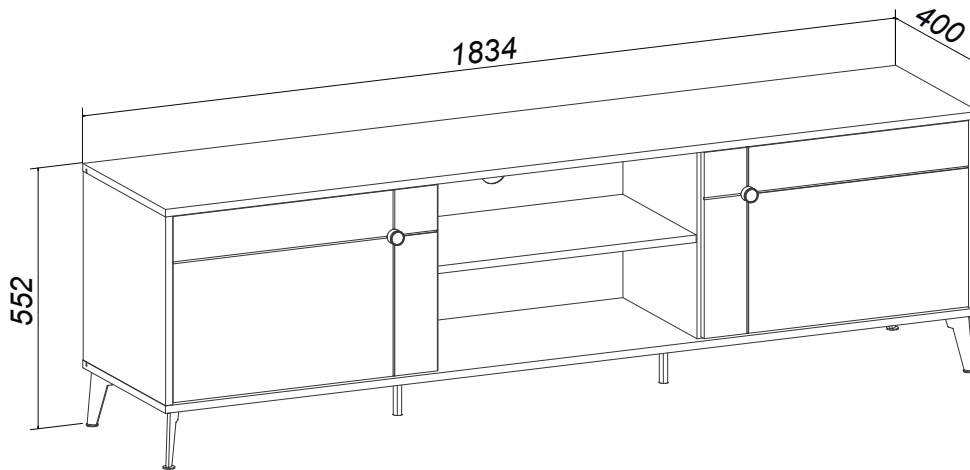

eindrücken / press in / enfoncer / wcisnaç
ribattere / zallaçit / Вкарайте / indrukken
benyomni / stlaçit' / vtisniti / tryck in
introducere prin apásare / вдавить



ausmessen / measure / mesurer /
misurare / opmeten / izmeriti / miara /
kimérni / izmeriti / măsurare / измерить
změřit / Измерете / mät upp / zmierzyc



drücken / press / presser / stisknout /
Нагиснете / vtisniti / nasinac / drukken /
pritisnuti / nacinac / pritisniti / нажать /
(meg)nyomni / apasare / tryck fast / nacinac



einschlagen / hammer in / beverni / sla in
frapper au marteau / infossare / Zabit' /
zarazit / Набийте / zabit / wbiç
introducere prin bãtaie / забить / zatlout



Drehen - wenden / przekreçit - odwróciç /
Keren - omdraaien / Girare - Ruotare /
Okrenuti - ubnuti / Retourner - renverser /
Zavърtete - obвърнете / Obrnite list /
Ítoarcetei - rotiçi / Vrid runt - vänd /
прокрутить - повернуть / otoiçit - obrátit
elforgatni - megfordítani



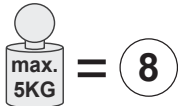
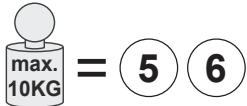
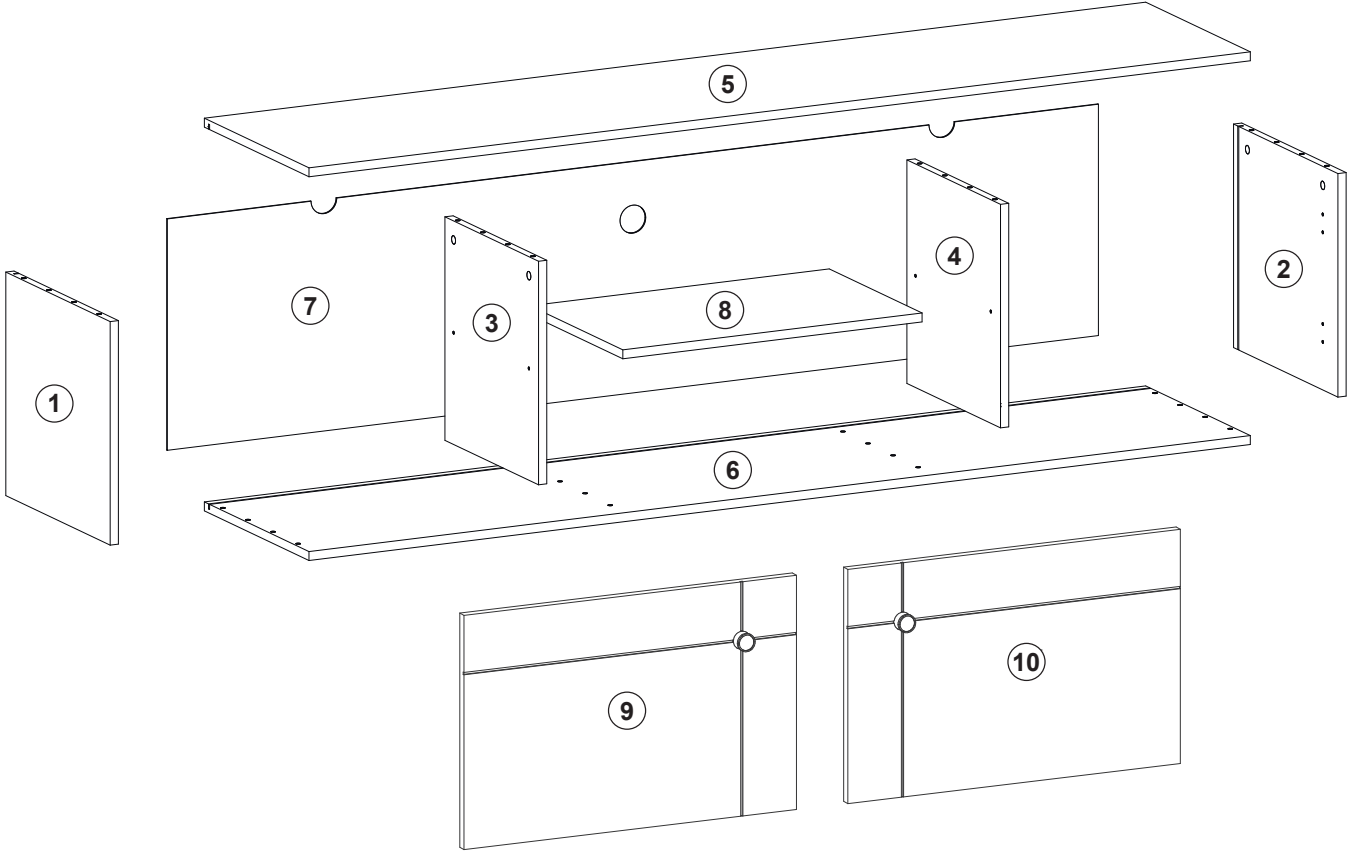







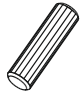

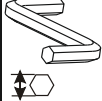

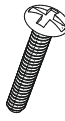

POINT

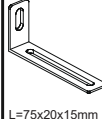
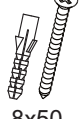

A	B (mm)		C	D
1	400	399	16	x1 1/2
2	400	399	16	x1 1/2
3	400	358	16	x1 1/2
4	400	358	16	x1 1/2
5	1834	400	16	x1 2/2
6	1834	400	16	x1 2/2
7	1814	414	2,5	x1 2/2
8	583	355	16	x1 1/2
9	594	396	16	x1 1/2
10	594	396	16	x1 1/2
B1			x1	1/2

POINT

B1

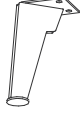
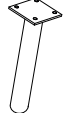
A0  Ø8x30 x16	C1  16 mm x8	Z  4mm x1	B1  Ø6,4x50 x8	D11  3,5x16 x12	L14  x2	D19  4x16 x2	C2  L-44 x8	C07  Ø20 x4	C08  Ø20 x4
J8  x4	D17  3,5x16 x26	N14  L=75x20x15mm x2	E2  8x50 x2	M1  x16	D14  3x15 x16	N1  x4	T10  x4	T12  x2	

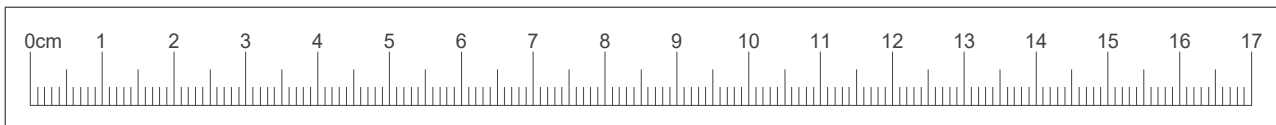

1

N14 L=75x20x15mm x2	D11 3,5x16 x4	J8 x4	C2 L-44 x8	C1 16 mm x8	A0 Ø8x30 x16
---	---------------------------------------	----------------------------	------------------------------------	-------------------------------------	--------------------------------------

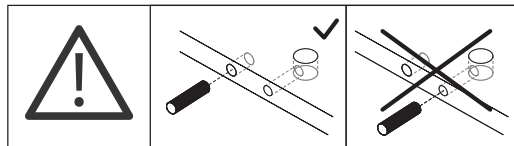
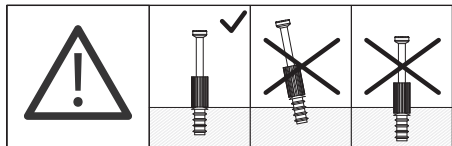
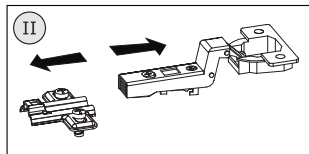
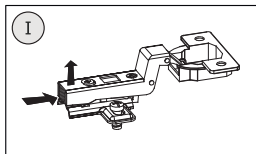
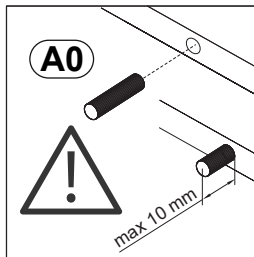
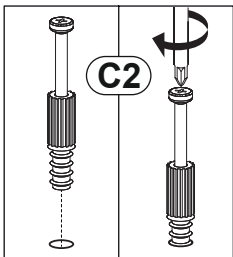
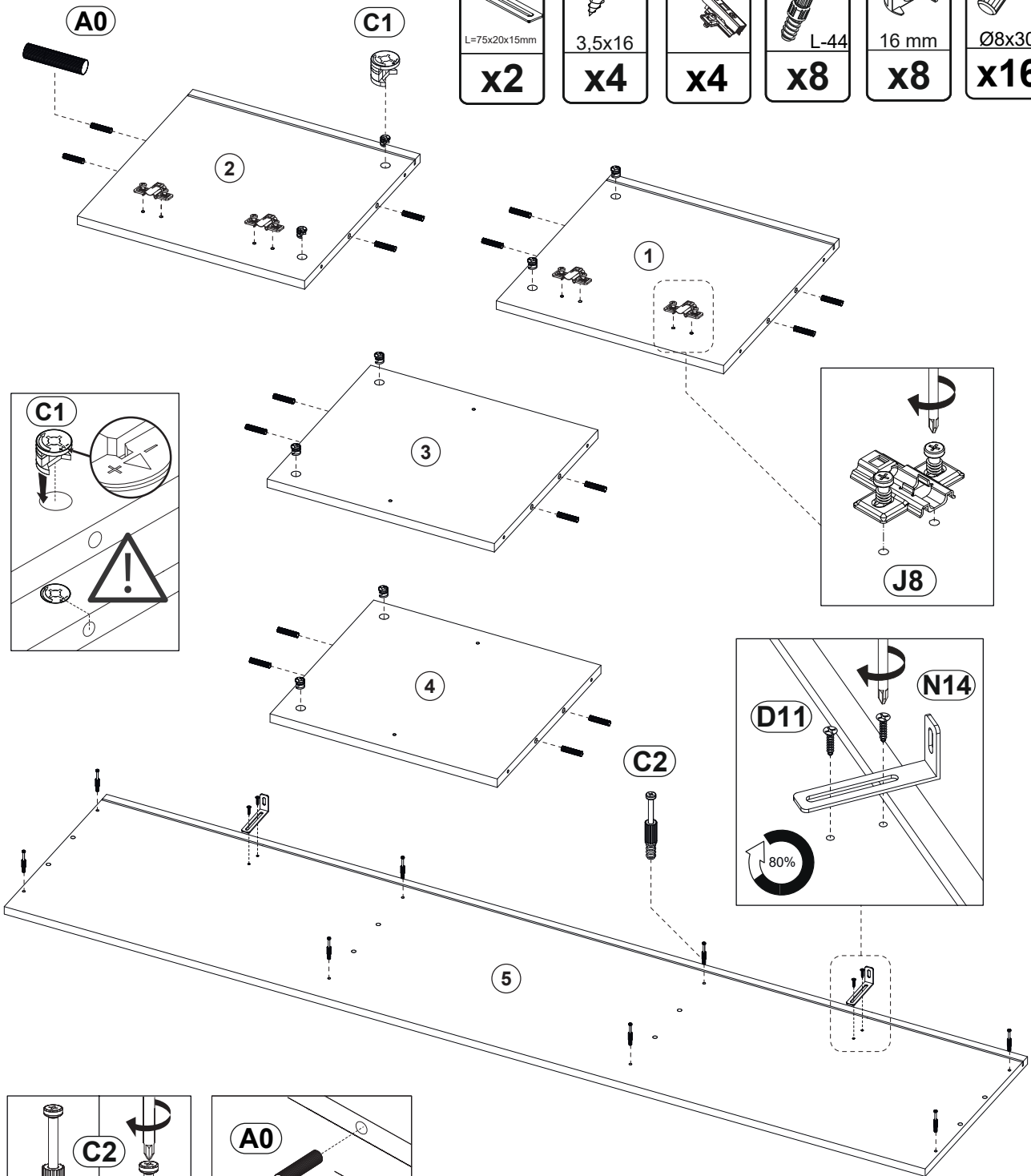

2

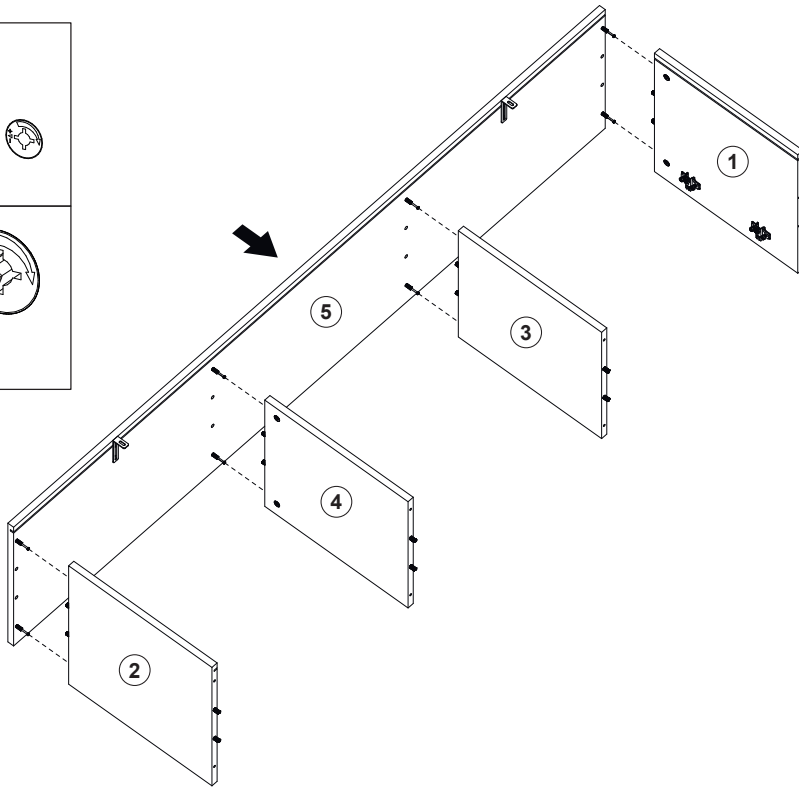
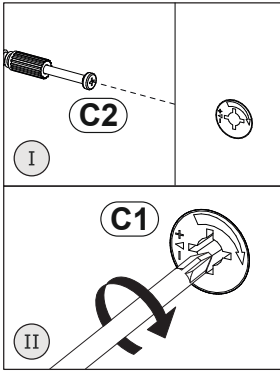

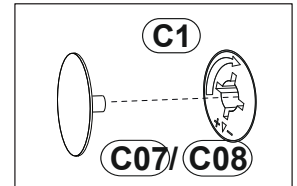

C07	C08
Ø20	Ø20
x4	x4

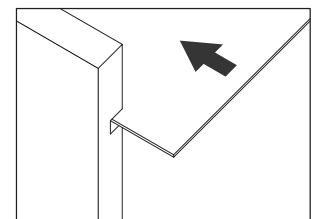
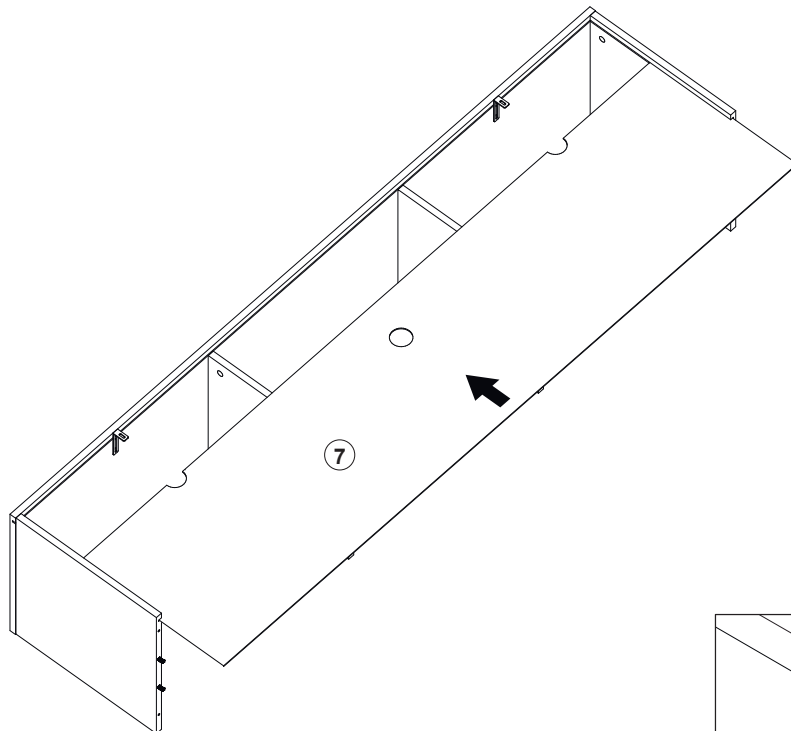

3



4



Z

 4mm
x1

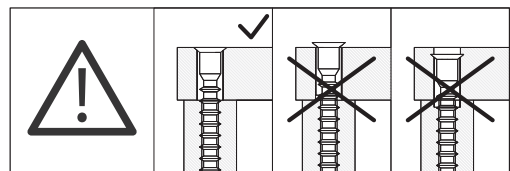
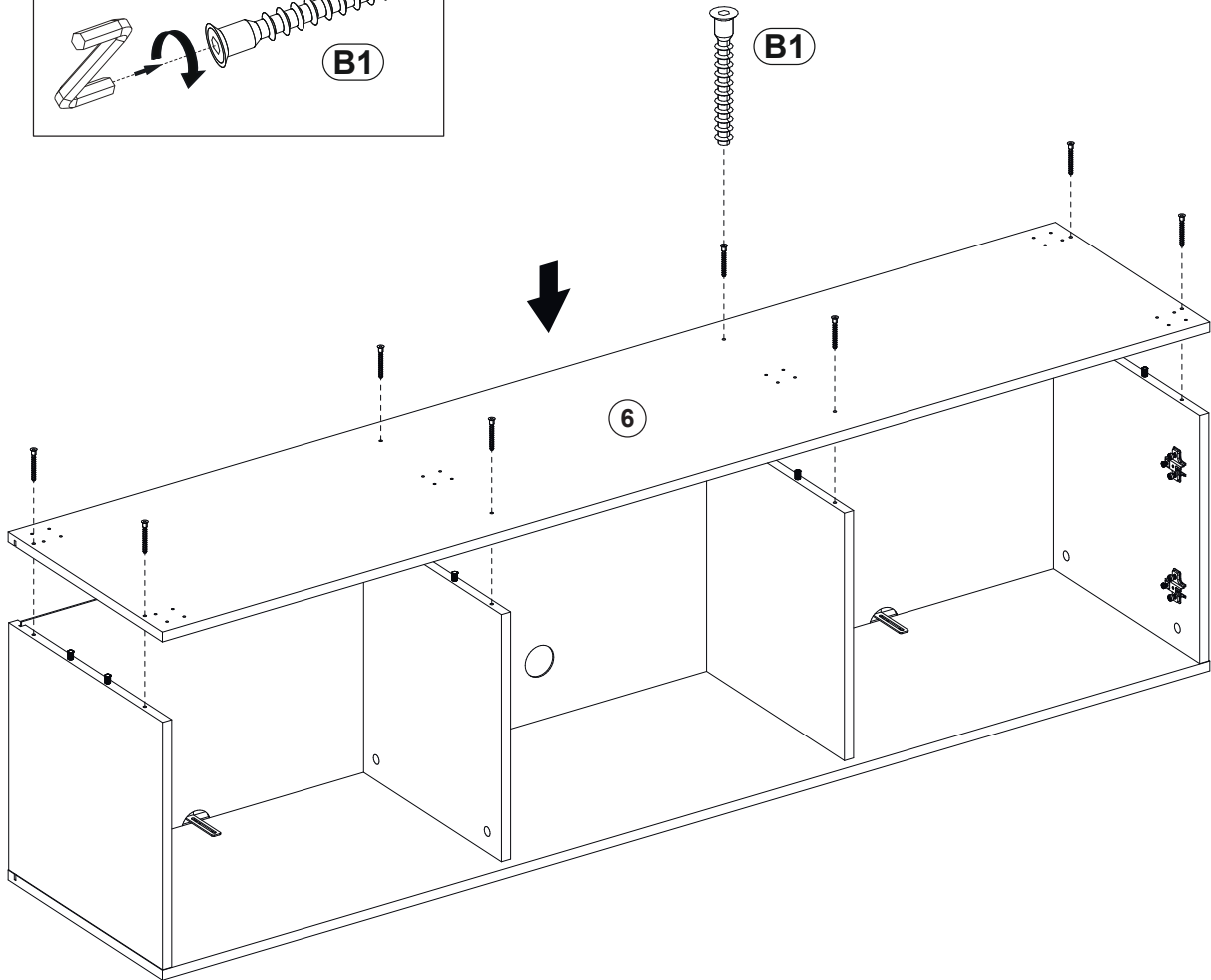
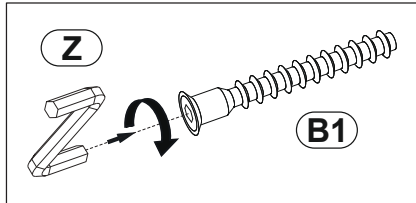
B1

Ø6,4x50
x8



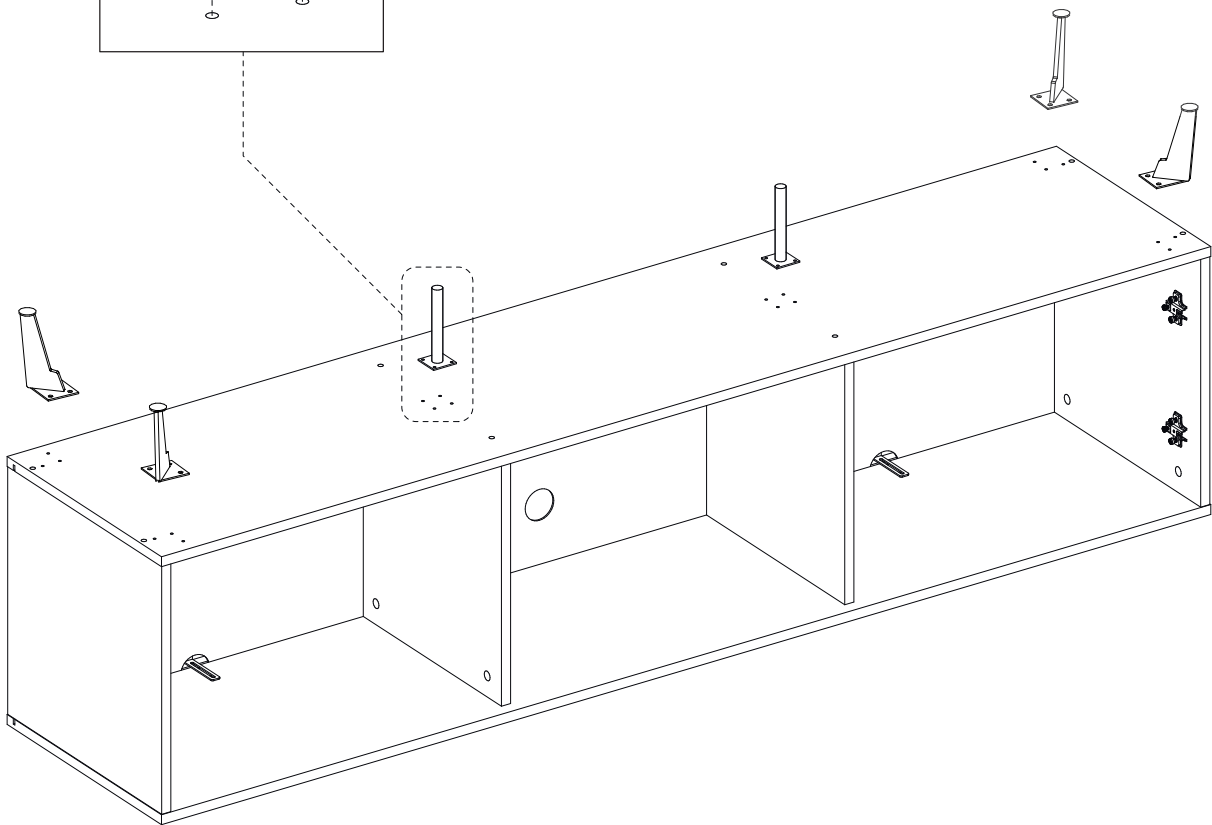
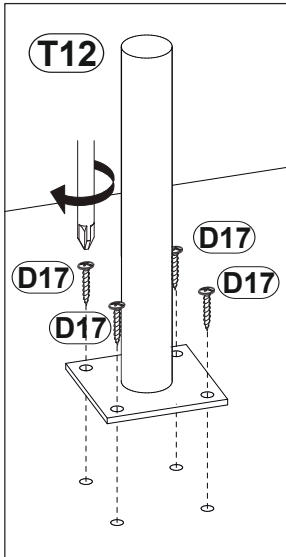

5

D17	T10	T12
		
3.5x16		
x20	x4	x2



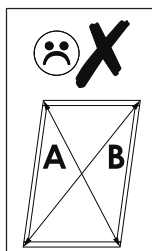
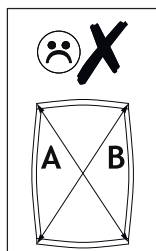
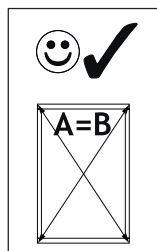
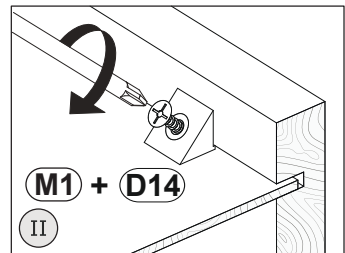
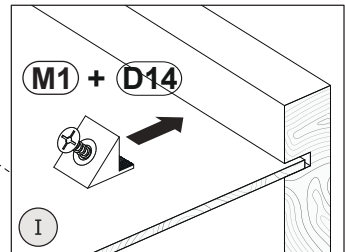
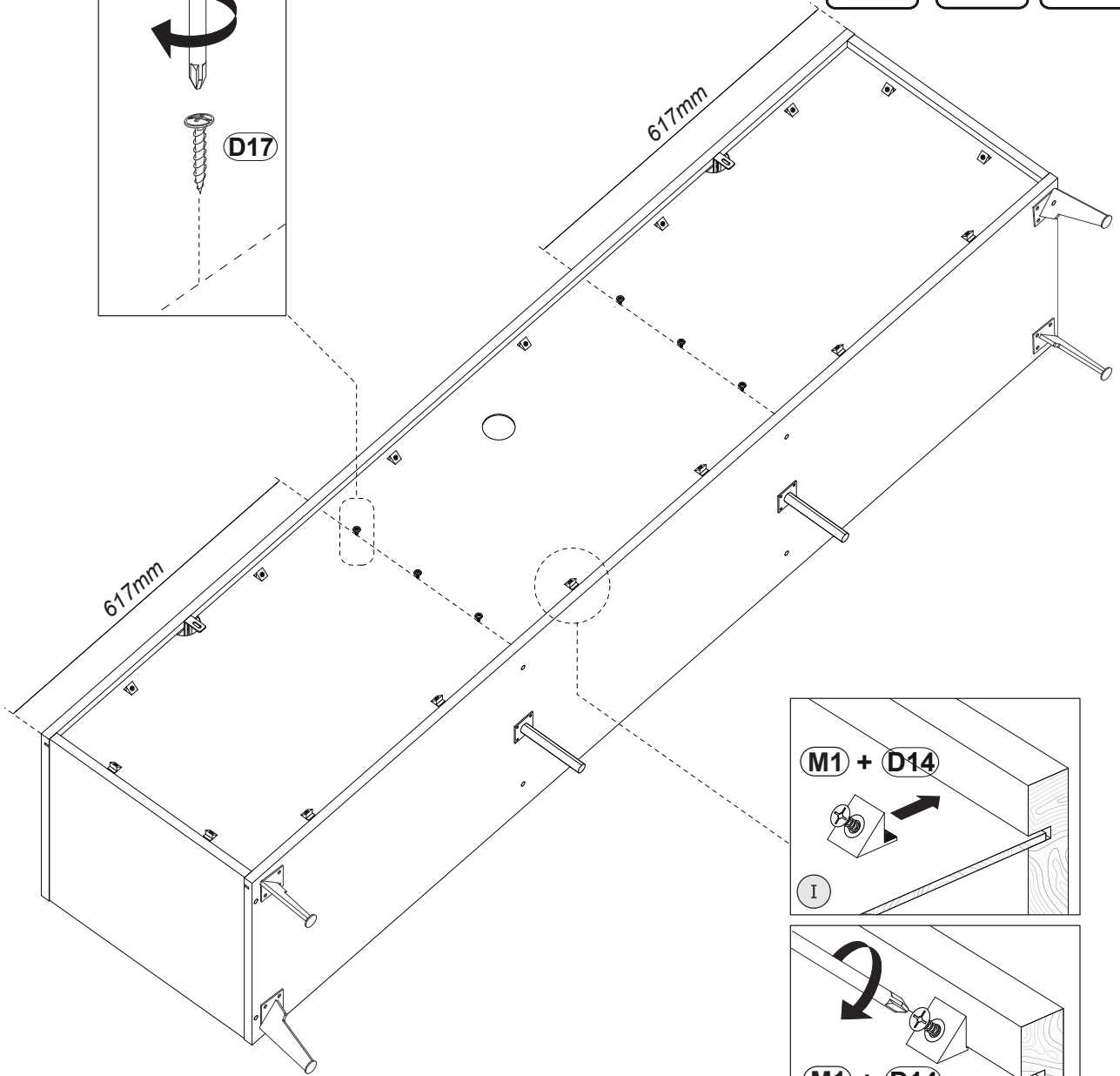
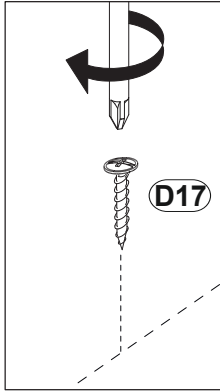

6

M1	D14	D17
		
	3x15	3.5x16
x16	x16	x6

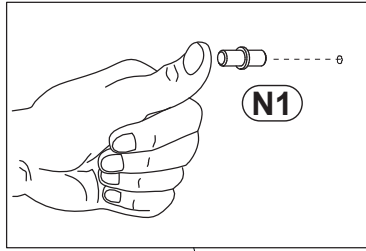

7

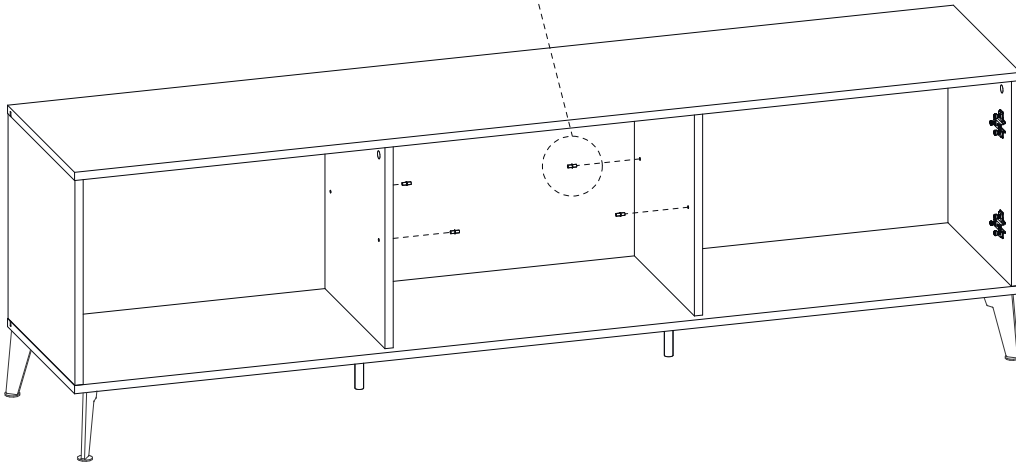

N1

x4

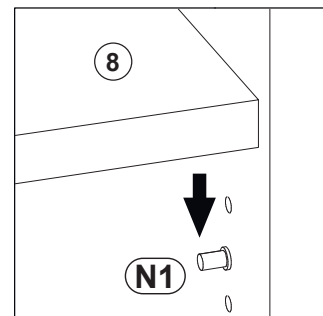
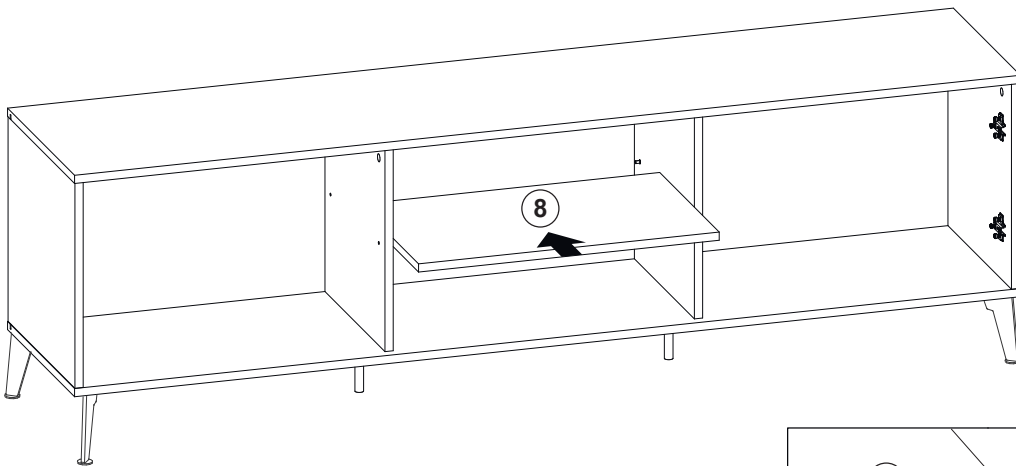

8

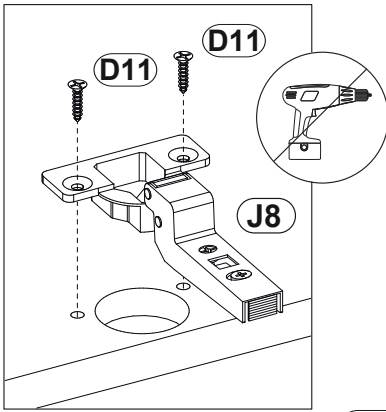

9



J8	D11	L14	D19
x4	x8	x2	x2

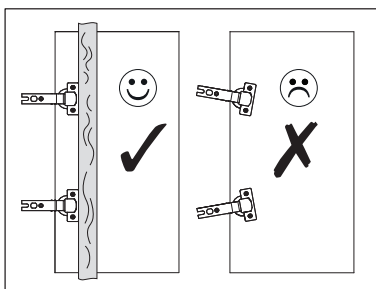
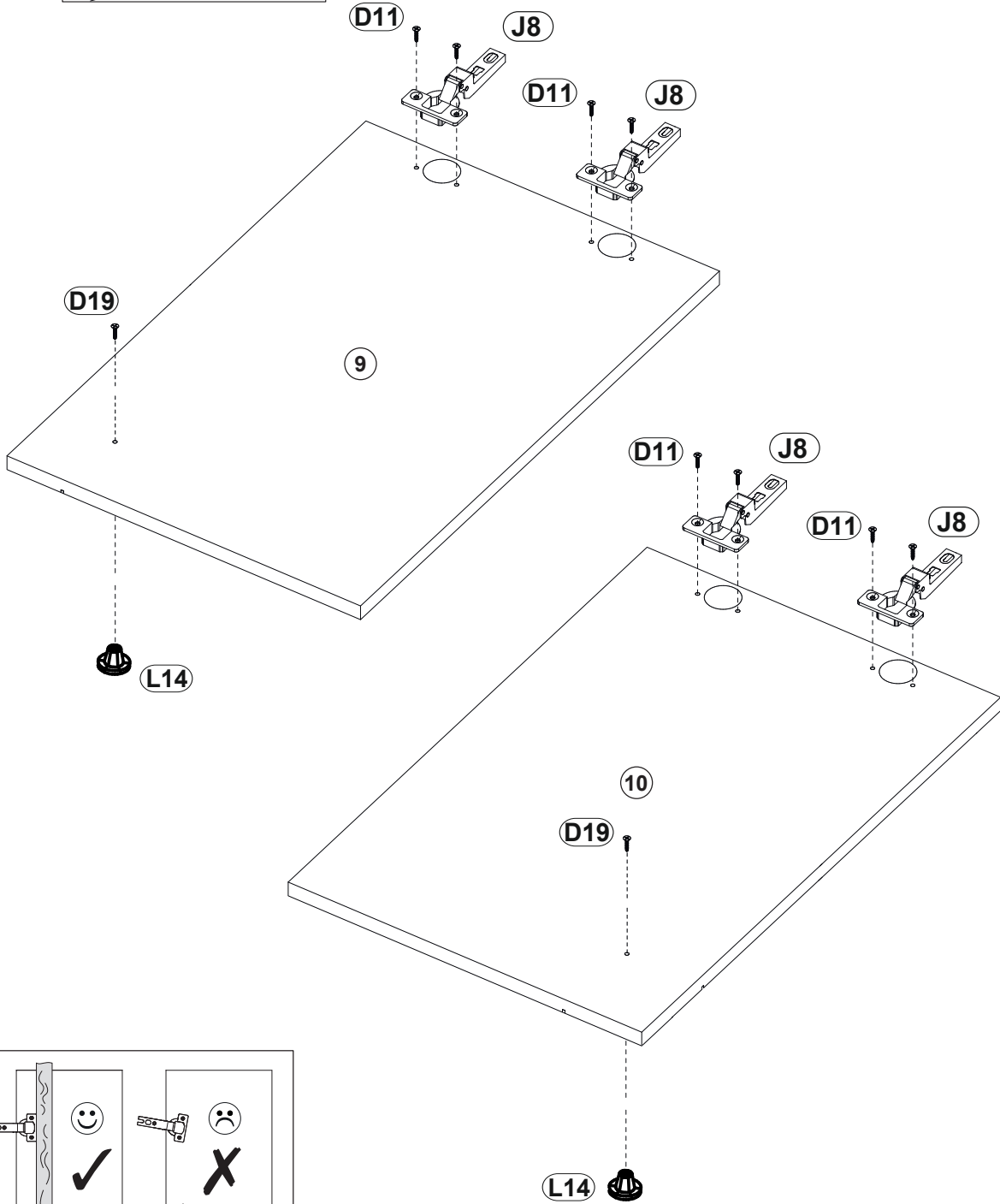

10

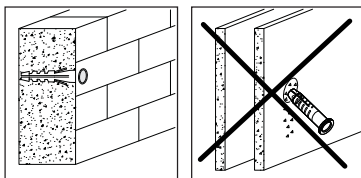

E2

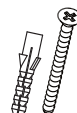

8x50

x2

